



21.5" multi-touch monitor with edge-to-edge glass, anti fingerprint coating, active stylus support (MPP 2.0) and a flexible stand

The ProLite T2255MSC with its Full HD (1920x1080) resolution and accurate PCAP 10 point touch technology, delivers a seamless and accurate touch response. Featuring IPS LCD screen technology, it offers exceptional colour performance and wide viewing angles. A special Nano coating ensures a smoother touch and less resistance in the swipe. It makes the screen less static and susceptible to dirt, dust and fingerprints. The monitor supports MPP2.0 (Microsoft Pen Protocol) technology, which is used in digital pens and styluses for use with compatible devices. The pen or stylus can interact with the ProLite T2255MSC, allowing users to write, draw, and navigate on the screen. It is very precise and supports tilt functionality, meaning the users can adjust the thickness and angle of their lines by tilting the pen, providing a more natural and intuitive writing and drawing experience. Its flexible stand can be positioned at several angles creating a comfortable and ergonomic user experience. A perfect choice for a vast array of creative applications.



MPP2.0 Support

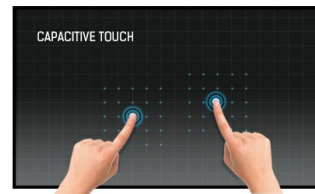

Dokunmatik teknolojisi - Kapasitif (PCAP)

Bu teknoloji, ekranı kaplayan cama entegre edilmiş mikro ince tellerden oluşan bir sensör ızgarası kullanır. İnsan parmağı camın üzerine yerleştirildiğinde sensör ızgarasının elektriksel özellikleri değişir, dokunma algılanır. Cam kaplama sayesinde bu teknoloji son derece dayanıklıdır ve cam çizilse bile dokunma işlevi etkilenmez. Mükemmel görüntü performansı sunar ve insan parmağıyla (ayrıca lateks eldivenli) ve stylus kalemle çalışır.

01 EKRAN ÖZELLİKLERİ

Ekran Boyutu	21.5", 54.5cm
Diagonal	54.5cm
Panel	IPS
Çözünürlük	1920 x 1080 @60Hz (2.1 megapixel Full HD)
En-Boy Oranı	16:9
Panel Parlaklığı	400 cd/m ²
Parlaklık	360 cd/m ² (Dokunmatik ile)
Işık geçirgenliği	90%
Statik Kontrast	1000:1
Tepki süresi (GTG)	5ms
Görüntüleme Alanı	yatay/dikey: 178°/178°, sağ/sol: 89°/89°, yukarı/aşağı: 89°/89°
Yatay Sync	30 - 83kHz
Görüntülenebilir alan G x Y	478.7 x 260mm, 18.8 x 10.2"
Piksel Aralığı	0.249mm

02 DOKUNMATİK

Dokunmatik Nokta Sayısı	10 (HID, only with supported OS)
Dokunma doğruluğu	+/- 2mm
Desteklenen işletim sistemleri	Tüm iiyama monitörleri Tak ve Çalıştır özelliğine sahiptir ve Windows ve Linux ile uyumludur. Dokunmatik modeller için desteklenen işletim sistemiyle ilgili ayrıntılar için lütfen indirmeler bölümünde bulunan sürücü talimat dosyasına bakın.
Palm rejection	Evet

03 ARAYÜZLER / BAĞLANTILAR / KONTROLLER

Dijital sinyal girişi	HDMI x1 DisplayPort x1
Ses çıkışı	Mini jack x1 Hoparlör 2 x 3W
USB HUB	x2 (3.2 Gen 1 (5Gbps, DC5V, 900mA))

04 ÖZELLİKLER

Cam Sertliği	7H
OSD tuş kilidi	evet

05 GENEL

Kontrol Düğmeleri	Joystick: right / menu / enter, left / input / exit, up / eco, down
Kullanıcı kontrolleri	Picture adjust (brightness, contrast, i-Style Color, adv. contrast, ECO, OverDrive, X-Res technology), color settings (gamma, RGB range, color temp.), image settings (video mode adjust, blue light reducer, sharp and soft), OSD (horizontal pos., vertical pos., OSD time, OSD background, language, display information), extra (reset, DDC/CI, signal select, volume, mute, opening logo, led, touch switch)
Mavi ışık azaltıcı	evet
Flicker free	evet

06 MEKANİK

Eğim açısı	15° yukarı; 70° aşağı
------------	-----------------------

MTBF

50000 saat (arka ışık hariç)

07 PAKET İÇERİĞİNDEKİ AKSESUARLAR**Kablolar**

güç, USB, HDMI

08 GÜÇ YÖNETİMİ**Güç Kaynağı**

AC 100 - 240V, 50/60Hz

Güç Tüketimi

16W tipik, 1.5W stand by, 0.3W off mode

09 SÜRDÜRÜLEBİLİRLİK**Yönetmelikler**

, , , , , , , cTUVus

10 ÖLÇÜLER / AĞIRLIK**Ürün boyutları G x Y x D**

493.5 x 289.5 x 48.5mm

Ağırlık (kutu hariç)

3.2kg

EAN kodu

4948570121625

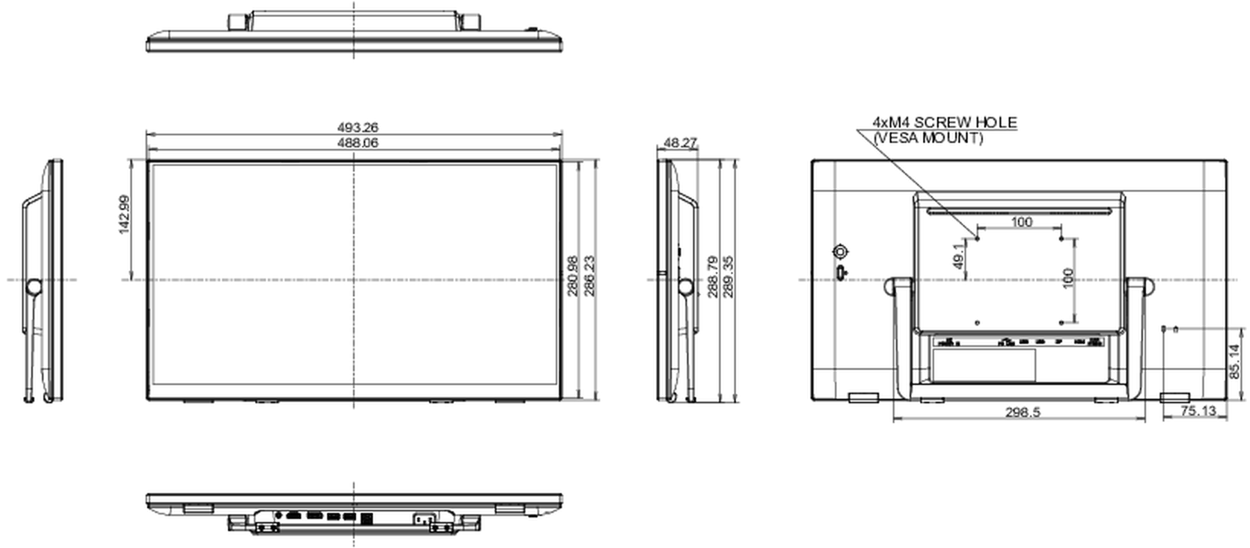

All trademarks and registered trademarks acknowledged. E & O E. Specification subject to change without notice. All LCD's comply with ISO-9241-307:2008 in connection with pixel defects.

© IIYAMA CORPORATION. ALL RIGHTS RESERVED

28.12.2024 01:00:47