

# USER MANUAL

# *ProLite*

## LCD Monitor

ENGLISH

### *ProLite B2875UHSU*

Thank you very much for choosing the iiyama LCD monitor.

We recommend that you take a few minutes to read this comprehensive manual carefully before installing and switching on the monitor. Please keep this manual in a safe place for your future reference.



## Dear user, we congratulate you on the purchase of your iiyama LCD.

For details on warranty and locally used pixel policies that apply directly after installation of your product please check the iiyama website.

## To report a fault, please contact your local support centre found at [www.iiyama.com/service](http://www.iiyama.com/service)

### Things to check before you call the iiyama information line

- | if the power cable is connected securely and turned on?
- | if the display has been turned on?
- | if the signal cable is connected securely and the correct input selected?
- | if the computer has been restarted with the display connected?
- | if the graphics card is correctly installed with the latest drivers possible?
- | if the correct native resolution has been selected via 'Display Properties'?
- | If the R/G/B signal configuration is correct?
- | if the displays On Screen Menu is shown?
- | if the correct brightness and contrast settings have been set?
- | if given display tolerances and compatibility have been considered?
- | if via the On Screen Menu you have performed a Factory Reset/Recall?

### Before reporting the screen defect, please prepare the following information/evidence:

- | model number \*
- | purchase receipt and serial number \*
- | name and address for collection
- | telephone/fax number, for availability during the day
- | convenient collection date (date, time)
- | short description of the defect

### Important Note:

If there is no fault found in the collected equipment after inspection, the transferring party shall incur charges for transport and administration.

If you have checked all of the above and there is still no picture, call our information line for assistance in your country.

\* see the identification plate on the back of the case.

## CE MARKING DECLARATION OF CONFORMITY

This LCD monitor complies with the requirements of the EC/EU Directive 2014/30/EU "EMC Directive", 2014/35/EU "Low Voltage Directive", 2009/125/EC "ErP Directive" and 2011/65/EU "RoHS Directive".

The electro-magnetic susceptibility has been chosen at a level that gives correct operation in residential areas, business and light industrial premises and small-scale enterprises, inside as well as outside of the buildings. All places of operation are characterised by their connection to the public low voltage power supply system.

IYYAMA CORPORATION: Wijkermeerstraat 8, 2131 HA Hoofddorp, The Netherlands

Model No. : PL2875UH



We recommend recycling of used product. Please contact your dealer or iiyama service center. Recycle information is obtained via the Internet, using the address: <http://www.iiyama.com>

You can access the Web page of different countries from there.

- We reserve the right to change specifications without notice.
- All trademarks used in this user manual are the property of their respective owners.
- Eprel registration number B2875UHSU-B1 A : 363908

# TABLE OF CONTENTS

FOR YOUR SAFETY.....	1
SAFETY PRECAUTIONS.....	1
SPECIAL NOTES ON LCD MONITORS.....	3
CUSTOMER SERVICE.....	3
CLEANING.....	3
BEFORE YOU OPERATE THE MONITOR.....	4
FEATURES.....	4
CHECKING THE CONTENTS OF THE PACKAGE.....	4
INSTALLATION.....	5
FITTING AND REMOVAL OF BASE.....	6
CONTROLS AND CONNECTORS.....	7
CONNECTING YOUR MONITOR.....	8
COMPUTER SETTING.....	9
ADJUSTING THE HEIGHT AND THE VIEWING ANGLE.....	9
PANEL ROTATION.....	9
OPERATING THE MONITOR.....	10
ADJUSTMENT MENU CONTENTS.....	11
SCREEN ADJUSTMENTS.....	18
STANDBY FEATURE.....	21
TROUBLE SHOOTING.....	22
RECYCLING INFORMATION.....	23
APPENDIX.....	24
SPECIFICATIONS.....	24
DIMENSIONS.....	25
COMPLIANT TIMING.....	26

# FOR YOUR SAFETY

## SAFETY PRECAUTIONS

### WARNING

#### **STOP OPERATING THE MONITOR WHEN YOU SENSE TROUBLE**

If you notice any abnormal phenomena such as smoke, strange sounds or fumes, unplug the monitor and contact your dealer or iiyama service center immediately. Further use may be dangerous and can cause fire or electric shock.

#### **NEVER REMOVE THE CABINET**

High voltage circuits are inside the monitor. Removing the cabinet may expose you to the danger of fire or electric shock.

#### **DO NOT PUT ANY OBJECT INTO THE MONITOR**

Do not put any solid objects or liquids such as water into the monitor. In case of an accident, unplug your monitor immediately and contact your dealer or iiyama service center. Using the monitor with any object inside may cause fire, electric shock or damage.

#### **INSTALL THE MONITOR ON A FLAT, STABLE SURFACE**

The monitor may cause an injury if it falls or is dropped.

#### **DO NOT USE THE MONITOR NEAR WATER**

Do not use where water may be splashed or spilt onto the monitor as it may cause fire or electric shock.

#### **OPERATE UNDER THE SPECIFIED POWER SUPPLY**

Be sure to operate the monitor only with the specified power supply. Use of an incorrect voltage will cause malfunction and may cause fire or electric shock.

#### **PROTECT THE CABLES**

Do not pull or bend the power cable and signal cable. Do not place the monitor or any other heavy objects on the cables. If damaged, the cables may cause fire or electric shock.

#### **ADVERSE WEATHER CONDITIONS**

It is advisable not to operate the monitor during a heavy thunder storm as the continual breaks in power may cause malfunction. It is also advised not to touch the plug in these circumstances as it may cause electric shock.

## CAUTION

### INSTALLATION LOCATION

Do not install the monitor where sudden temperature changes may occur, or in humid, dusty or smoky areas as it may cause fire, electric shock or damage. You should also avoid areas where the sun shines directly on the monitor.

### DO NOT PLACE THE MONITOR IN A HAZARDOUS POSITION

The monitor may topple and cause injury if not suitably located. Please also ensure that you do not place any heavy objects on the monitor, and that all cables are routed such that children may not pull the cables and possibly cause injury.

### MAINTAIN GOOD VENTILATION

Ventilation slots are provided to keep the monitor from overheating. Covering the slots may cause fire. To allow adequate air circulation, place the monitor at least 10cm (or 4 inches) from any walls. When removing the tilt stand, the ventilation slots on the back side of the monitor can be blocked. This may overheat the monitor and may cause fire or damage. Make sure to allow enough ventilation when removing the tilt stand. Operating the monitor on its back, side, upside down or on a carpet or any other soft material may also cause damage.

### DISCONNECT THE CABLES WHEN YOU MOVE THE MONITOR

When you move the monitor, turn off the power switch, unplug the monitor and be sure the signal cable is disconnected. If you do not disconnect them, it may cause fire or electric shock.

### UNPLUG THE MONITOR

If the monitor is not in use for a long period of time it is recommended that it is left unplugged to avoid accidents.

### HOLD THE PLUG WHEN DISCONNECTING

To disconnect the power cable or signal cable, always pull it by the plug. Never pull on the cable itself as this may cause fire or electric shock.

### DO NOT TOUCH THE PLUG WITH WET HANDS

Pulling or inserting the plug with wet hands may cause electric shock.

### WHEN YOU INSTALL THE MONITOR ON YOUR COMPUTER

Be sure the computer is strong enough to hold the weight of the monitor, otherwise, you may damage your computer.

### CAREFUL! PROTECT YOUR HANDS AND FINGERS

- Be careful not to hurt your fingers or hands when you change the height or the angle.
- Injury can occur if care is not taken to avoid finger contact with the displays base when adjusting the height. (Just for height adjustable model.)

### REMARK FOR 24/7 USAGE

This product is not specifically designed for 24/7 usage in all environments.

## OTHERS

### ERGONOMIC RECOMMENDATIONS

To eliminate eye fatigue, do not operate the monitor against a bright background or in a dark room. For optimal viewing comfort, the monitor should be just below eye level and 40-60 cm (16-24 inches) away from your eyes. When using the monitor over a prolonged time, a ten minute break every hour is recommended as looking at the screen continuously can cause eye strain.

## SPECIAL NOTES ON LCD MONITORS

The following symptoms are normal with LCD monitors and do not indicate a problem.

### NOTE

- When you first turn on the LCD monitor, the picture may not fit in the display area because of the type of computer that is used. In this case, adjust the picture position to the correct position.
- You may find slightly uneven brightness on the screen depending on the desktop pattern you use.
- Due to the nature of the LCD screen, an afterimage of the previous screen may remain after switching the image, when the same image is displayed for hours. In this case, the screen can be recovered slowly by changing the image or turning off the Power Switch for some hours.

## CUSTOMER SERVICE

### NOTE

- If you have to return your unit for service and the original packaging has been discarded, please contact your dealer or iiyama service center for advice or replacement packaging.

## CLEANING

### WARNING

- If you drop any materials or liquids such as water into the monitor when cleaning, unplug the power cable immediately and contact your dealer or iiyama service center.

### CAUTION

- For safety reasons, turn off the power switch and unplug the monitor before you clean it.

### NOTE

- To protect the LCD panel, do not scratch or rub the screen with a hard object.
- Never use any of the following strong solvents. These will damage the cabinet and the LCD screen.

Thinner	Spray-type cleaner
Benzine	Wax
Abrasive cleaner	Acid or Alkaline solvent

- Touching the cabinet with any product made from rubber or plastic for a long time may cause degeneration or loss of paint on the cabinet.

### CABINET

Stains can be removed with a cloth lightly moistened with a mild detergent solvent. Then wipe the cabinet with a soft dry cloth.

### LCD

Periodic cleaning with a soft dry cloth is recommended.

### SCREEN

Don't use tissue paper etc. because these will damage the LCD screen.

# BEFORE YOU OPERATE THE MONITOR

## FEATURES

- ◆ Supports Resolutions up to 3840 × 2160
- ◆ High Contrast 1000:1 (Typical), Adv. Contrast Function Available / Brightness 300cd/m<sup>2</sup> (Typical) / Quick Respons Time 5ms (Typical), 1ms (Gray to Gray)
- ◆ Supports AMD Radeon FreeSync™ technology (through DisplayPort-input)
- ◆ Blue Light Reducer
- ◆ Digital Character Smoothing
- ◆ USB3.0/2.0 Hub Function
- ◆ Stereo Speakers  
2 × 2.5W Stereo Speakers
- ◆ Standby Feature (VESA DPMS Compliant)
- ◆ VESA Mounting Standard (100mm×100mm) Compliant
- ◆ Keyhole for Security Lock

## CHECKING THE CONTENTS OF THE PACKAGE

The following accessories are included in your package. Check to see if they are enclosed with the monitor. If anything is missing or damaged, please contact your local iiyama dealer or regional iiyama office.

- |                |                     |                                 |
|----------------|---------------------|---------------------------------|
| ■ Power Cable* | ■ HDMI Cable        | ■ DisplayPort Cable             |
| ■ USB Cable    | ■ Stand-Base        | ■ Screw for stand fixing (3pcs) |
| ■ Safety Guide | ■ Quick Start Guide |                                 |

### CAUTION

\* The rating of the Power Cable enclosed in 120V area is 10A/125V. If you are using a power supply higher than this rating, then a power cable with a rating of 10A/250V must be used. However, all guarantees and warranties are void for any problems or damage caused by a power cable not supplied by iiyama. An approved power cable greater or equal to H05VVVF, 3G, 0.75mm<sup>2</sup> must be used.



## INSTALLATION

- WARNING** ■ Before installation, make sure the wall, ceiling or desktop arm is strong enough to hold the necessary weight of the display and the mount.

### < WALL MOUNTING >

- WARNING** ■ When you use with the wall mounting, in consideration of thickness of the mounting stage, tighten the M4 Screws (4pcs) with washer which "L" length is 7mm to fasten the monitor. Using the screw longer than this may cause electric shock or damage because it may contact with the electrical parts inside the monitor.

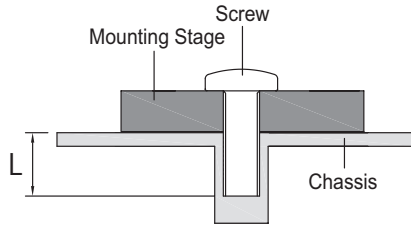

### < LANDSCAPE MODE >

#### Available

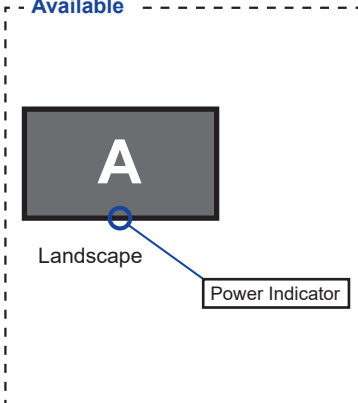

#### Not Available

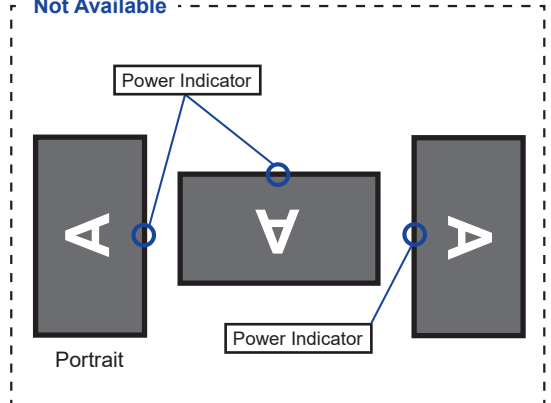

This monitor can only be used in landscape. Do not rotate or operate the monitor in any other orientation than landscape.

## FITTING AND REMOVAL OF BASE

### CAUTION

- Put the monitor on a stable surface. The monitor may cause injury or damage if it falls or is dropped.
- Do not give a strong impact to the monitor. It may cause damage.
- Unplug the monitor before removal or installation to avoid an electric shock or a damage.

### <Installation>

- ① Put a piece of soft cloth on the table beforehand to prevent the monitor from being scratched.  
Lay the monitor flat on a table with front face down.
- ② Hold the monitor and install the Stand-Base.
- ③ Use the 'thumb screws' provided to secure the base to the monitor.

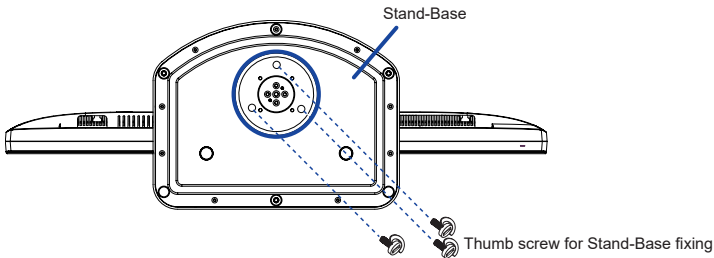

### <Removal>

- ① Put a piece of soft cloth on the table beforehand to prevent the monitor from being scratched.  
Lay the monitor flat on a table with front face down.
- ② Remove the 'thumb screws' to remove the base from the monitor.

### <Stopper>

Put the monitor on a flat surface. Press the stopper at the back of the stand while pushing the monitor from the top. Careful attention is required as the monitor is sprung loaded and the stand may expand quickly.

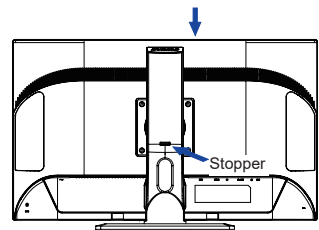



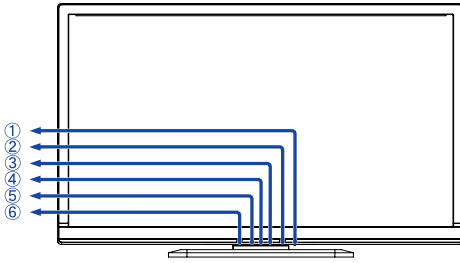



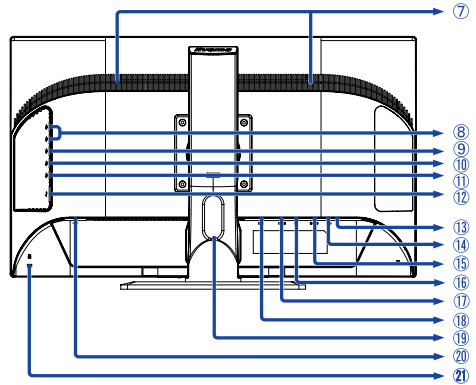



## CONTROLS AND CONNECTORS



<Front>



<Back>

- ① Power Switch (  )
- ② Menu Button (MENU)
- ③ Scroll Up / Volume Button ( + /  )
- ④ Power Indicator
- NOTE** Blue: Normal operation  
Orange: Standby Mode
- ⑤ Scroll Down / ECO Mode Button ( - /  )
- ⑥ Input / Auto / Exit Button (AUTO)
- ⑦ Speakers
- ⑧ USB(2.0) Downstream Connector (  5V, 500mA)
- ⑨ USB(3.0 Battery Charger) Downstream Connector (  5V, 900mA)
- ⑩ USB(3.0) Downstream Connector (  5V, 900mA)
- ⑪ USB Upstream Connector (  )
- ⑫ Main Power Switch ( | (ON) / ○ (OFF) )
- ⑬ Headphone Connector (  )
- ⑭ Audio Connector (  )
- ⑮ VGA Connector (D-SUB)
- ⑯ DisplayPort Connector (  )
- ⑰ HDMI Connector (HDMI)
- ⑱ DVI-D Connector (DVI)
- ⑲ Cable Hole
- ⑳ AC Connector ( ~ : Alternating current ) ( ~ )
- ㉑ Keyhole for Security Lock

**NOTE** You can fasten a security lock and cable to prevent the monitor from being removed without your permission.

## CONNECTING YOUR MONITOR

- ① Ensure that both the computer and the monitor are switched off.
- ② Connect the computer to the monitor with the signal cable.
- ③ Connect the monitor to the audio equipment with the Audio Cable for computer when using the audio features.
- ④ Connect the computer to the monitor with the USB Cable.
- ⑤ Connect the Power Cable to the monitor first and then to the power source.
- ⑥ Turn on your monitor (Main Power Switch and Power Switch) and computer.

### NOTE

- Make sure that the building installation has a circuit breaker of 120/240V, 20A (maximum).
- The signal cables used for connecting the computer and monitor may vary with the type of computer used. An incorrect connection may cause serious damage to both the monitor and the computer. The cable supplied with the monitor is for a standard connector. If a special cable is required please contact your local iiyama dealer or regional iiyama office.
- Make sure you tighten the finger screws at each end of the signal cable.
- The Class I pluggable equipment Type A must be connected to protective earth.
- The socket-outlet shall be installed near the equipment and shall be easily accessible.
- Excessive sound pressure from ear-/headphones can cause hearing damage/hearing loss.

[Example of Connection]

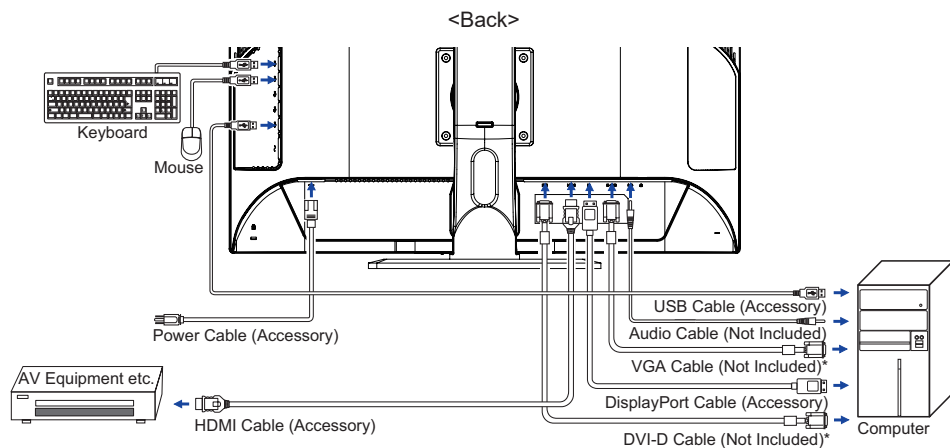

\* Cable is not supplied with the monitor. If you use low quality Cable, it may cause a result of electro-magnetic interference. Please contact the iiyama Support Centre in your country if you wish to connect the monitor via the VGA or DVI input.

### [ Collect Cables ]

Put the cables through the cable hole to bundle them.

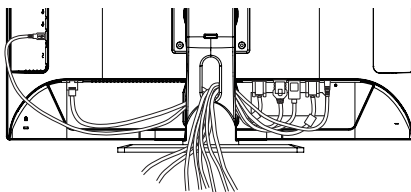

## COMPUTER SETTING

### ■ Signal Timing

Change to the desired signal timing listed on page 26: COMPLIANT TIMING.

## ADJUSTING THE HEIGHT AND THE VIEWING ANGLE

- For optimal viewing it is recommended to position yourself directly opposite to the full face of the monitor, then adjust the monitor's height and angle to your own preference.
- Hold the panel so that the monitor does not topple when you change the monitor's height or angle.
- You are able to adjust the monitor's height up to 130mm, angle up to 45 degrees right and left, 17 degrees upward.

### NOTE

- Do not touch the LCD screen when you change the height or the angle. It may cause damage or break the LCD screen.
- Careful attention is required not to pinch your fingers or hands into the moving part of the stand when you change the height or the angle.
- Injury can occur if care is not taken to avoid finger contact with the displays base when adjusting the height.

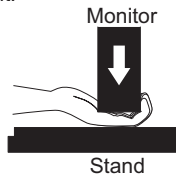
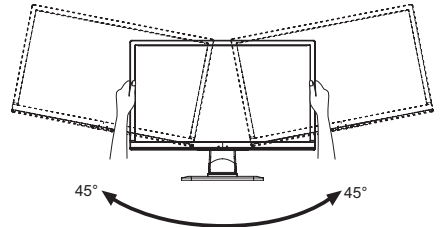
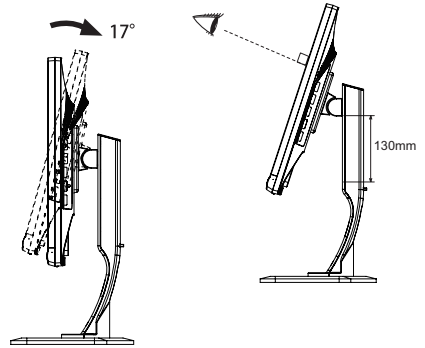

## PANEL ROTATION

Not available on this model.

# OPERATING THE MONITOR

To create the best picture, your iiyama LCD monitor has been preset at the factory with the COMPLIANT TIMING shown on page 26. You are also able to adjust the picture by following the button operation shown below. For more detailed adjustments, see page 18 for SCREEN ADJUSTMENTS.

- 1 Press the MENU Button to start the On Screen Display feature. There are additional Menu items which can be switched by using the + / - Buttons.

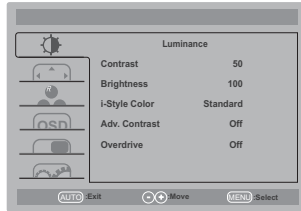

- 2 Select the Menu item which contains the adjustment icon relating to the adjustment you want to make. Press the MENU Button. Then, use the + / - Buttons to highlight the desired adjustment icon.
- 3 Press the MENU Button again. Use the + / - Buttons to make the appropriate adjustment or setting.
- 4 Press the AUTO Button to leave the menu, and the settings you just made would be automatically saved.

For example, to correct for vertical position, select Menu item of Image Setup and then press the MENU Button. Then, select V.Position by using the + / - Buttons.

An adjustment page appears after you press the MENU Button. Then, use the + / - Buttons to change the vertical position settings. The vertical position of the overall display should be changing accordingly while you are doing this.

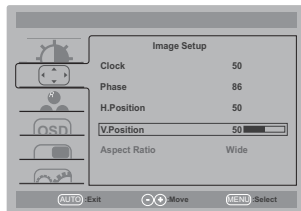

Press the AUTO Button lastly, it ends, all changes are saved in the memory.

## NOTE

- When button operations are aborted during adjustment, On-Screen Display disappears when the time set for the OSD Timeout has passed. Also, the AUTO button can be used to return previous menu and turn off the On-Screen Display.
- Any changes are automatically saved in the memory when the On Screen Display disappears. Turning off the power should be avoided while using the Menu.
- Adjustments for H. / V. Position, Clock and Phase are saved for each signal timing. Except for these adjustments, all other adjustments have only one setting which applies to all signal timings.

# ADJUSTMENT MENU CONTENTS

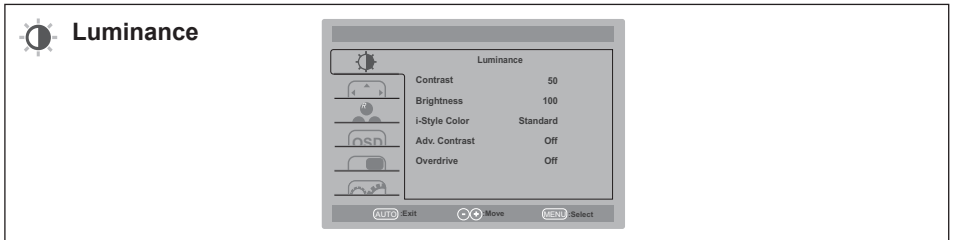

Adjustment Item	Problem / Option	Button to Press
Contrast	Too dull	<input type="button" value="+"/>
	Too intense	<input type="button" value="-"/>
Brightness * <sup>1</sup>	Too dark	<input type="button" value="+"/>
	Too bright	<input type="button" value="-"/>
i-Style Color * <sup>2</sup>	Standard	For general windows environment and monitor default setting.
	Text	For text editing and viewing in a word processing environment.
	Internet	For internet environment.
	Game	For PC game environment.
	Movie	For movie and video environment.
	Sports	For sport environment.
Adv. Contrast * <sup>3</sup>	Off	Typical Contrast Ratio
	On	Increased Contrast Ratio
<p><b>NOTE</b> Adv. Contrast adjusts brightness according to the image, and improve the contrast ratio during movie playing.            Contrast, Brightness, Color Temp., Eco, i-Style Color and Blue Light Reducer cannot be adjusted and selected while Adv. Contrast is active.</p>		
Overdrive * <sup>4</sup>	Off / -2 / -1 / 0 / +1 / +2	<input type="button" value="+"/> <input type="button" value="-"/>
	It will improve the gray level response time of the LCD panel. A higher level results in a faster response time.	

\*<sup>1</sup> Adjust the Brightness when you are using the monitor in a dark room and feel the screen is too bright. Brightness adjustment is disabled when Eco is activated.  
 \*<sup>2</sup> i-Style Color cannot be adjusted and selected while Blue Light Reducer is active.  
 \*<sup>3</sup> Adv. Contrast adjustment is disabled when PIP Setting is activated.  
 \*<sup>4</sup> When Overdrive is activated, some level of image retention will be caused.

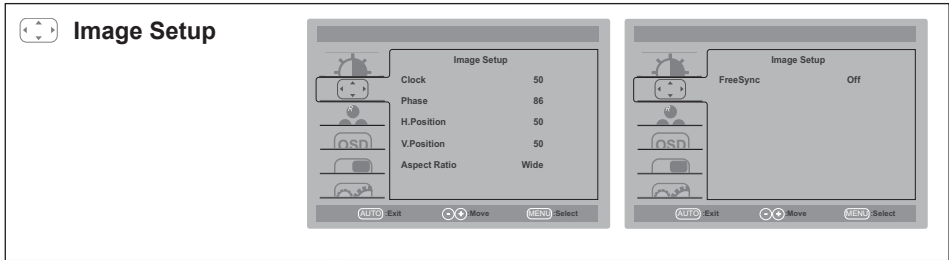

Adjustment Item	Problem / Option	Button to Press
Clock* <sup>1,2</sup>	Too narrow	<b>+</b>
	Too wide	<b>-</b>
Phase* <sup>1,2</sup>	To correct flickering text or lines	<b>+</b> <b>-</b>
H. Position* <sup>2</sup>	Too left	<b>+</b>
	Too right	<b>-</b>
V. Position* <sup>2</sup>	Too low	<b>+</b>
	Too high	<b>-</b>
Aspect Ratio	Wide	Expansion display
	4:3	Displays all picture in 4:3 aspect ratio.
	5:4	Displays all picture in 5:4 aspect ratio.
FreeSync* <sup>3</sup>	Off	The FreeSync function is turned off.
	On	Enable the FreeSync function.

\*<sup>1</sup> See page 18 for SCREEN ADJUSTMENTS.

\*<sup>2</sup> Only Analog Input.

\*<sup>3</sup> Only DisplayPort Input. FreeSync adjustment is disabled when PIP Setting is activated.





## Color Temp. \*

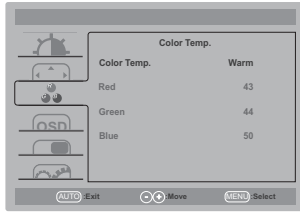

Adjustment Item	Problem / Option		Button to Press	
Color Temp.	Warm	Greenish white		
	Normal	Yellowish white		
	Cool	Bluish white		
	User	Red	Too weak	 <input type="button" value="+"/>
		Green		
		Blue		
sRGB	sRGB			

### NOTE

- sRGB is an international standard which defines and unifies the difference of color appearance between equipment.
- You can not adjust the Contrast, Brightness, i-Style Color and Eco during sRGB mode because those settings are locked.

\* Color Temp. cannot be adjusted and selected while Blue Light Reducer is active.

OSD OSD Setup

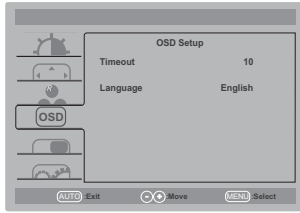

Adjustment Item	Problem / Option		Button to Press	
Timeout	You can set the OSD display duration time between 5 and 100 seconds.			<input data-bbox="954 379 1005 405" type="button" value="+"/> <input data-bbox="954 411 1005 437" type="button" value="-"/>
Language	English	English		Italiano
	Français	French	Česky	Czech
	Español	Spanish	Nederlands	Dutch
	Português	Portuguese	Polski	Polish
	Русский	Russian	日本語	Japanese
	Deutsch	German		

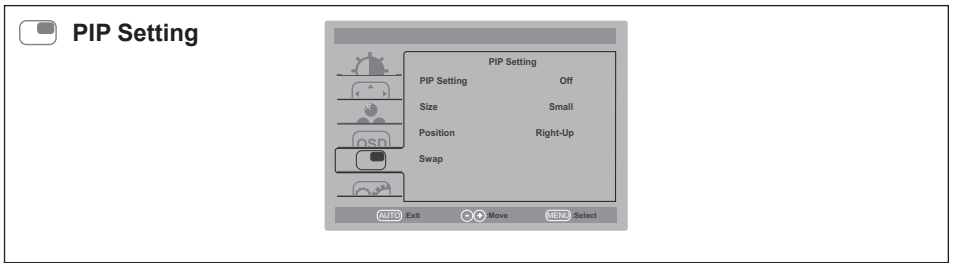

Adjustment Item	Problem / Option		Button to Press
PIP Setting	When there are two or more input signals, you can display PIP / PBP.		
	Off	PIP Setting is turned off.	
	PIP *	Display the Sub screen in the main screen.	
	PBP *	Divide screen display in Left and Right.	
Size	Small	Reduce the size of the Sub screen.	
	Middle	Normal size	
	Large	Increase the size of the Sub screen.	
Position	Right-Up	Move the sub screen to the top right corner.	
	Left-Up	Move the sub screen to the top left corner.	
	Right-Down	Move the sub screen to the bottom right corner.	
	Left-Down	Move the sub screen to the bottom left corner.	
Swap	Swap the Main/Sub or Right/Left screens when PiP or PbP mode is active.		

\* PiP = Picture In Picture

With this function, you can display two different pictures.

Display Sub screen in Main screen.

PbP = Picture By Picture

With this function, you can display two different pictures.

Display Left and Right screen is divided.

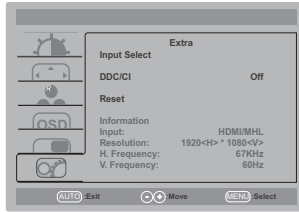

Adjustment Item		Problem / Option		Button to Press
Input Select	<b>Direct</b>	Main Source	VGA	Select the Analog (VGA) input.
			DVI	Select the Digital (DVI) input.
			HDMI	Select the Digital (HDMI) input.
			DP	Select the Digital (DisplayPort) input.
		Sub Source	VGA	Select the Analog (VGA) input.
			DVI	Select the Digital (DVI) input.
			HDMI	Select the Digital (HDMI) input.
			DP	Select the Digital (DisplayPort) input.
		DisplayPort Mode *1	DP1.2	Standard
			DP1.1	If any abnormal picture visible, you can change the setting to 1.1.
		HDMI *2	2.0	Standard
			1.4 *3	If any abnormal picture visible, you can change the setting to 1.4.
Auto-Switch Input	Off	Auto-Switch Input is Off.		
	On	If there is no signal source at the selected input signal, the input signal with the signal source is automatically selected.		
DDC / CI	Off	DDC / CI is Off.		
	On	DDC /CI is On.		
Reset	Yes	Factory-preset data is restored.		
	No	Return to Menu.		
Information		Displays information regarding the current input signal coming from the graphic card in your computer. <b>NOTE</b> See your graphic card user guide for more information about changing the resolution and refresh.		

\*1 Suitable for DisplayPort input only.

\*2 Suitable for HDMI input only.

\*3 When you select 1.4, the maximum support resolution is 3840x2160@30Hz.

**Direct**



You can skip the Menu items and directly display an option setting screen by using the following button operations.

- Input Select: Press the AUTO button when the Menu is not displayed.

**Direct**

You can skip the Menu items and directly display an option setting screen or an adjustment scale by using the following button operations.

- **Audio Adjust:** Press the + Button when the Menu is not displayed.  
Press the MENU button to switch the Volume / Audio Source.

Adjustment Item	Problem / Option	Button to Press
Volume	Too soft	
	Too loud	
Audio Source *	HDMI	Select the HDMI input.
	DP	Select the DisplayPort input.
	Line-In	Select the Line-In input.

\* Suitable for HDMI/DisplayPort input only.

- **Auto Configure:** Press and hold the AUTO Button for 2-3 seconds when the Menu is not displayed.

**Only Analog Input**

Adjustment Item	Problem / Option	Button to Press
Auto Configure *	Adjust H. / V. Position, Clock and Phase automatically.	

\* For best results, use the Auto Adjust in conjunction with the adjustment pattern. See page 18 for SCREEN ADJUSTMENTS.

- **Eco \*** : Press the - Button when the Menu is not displayed.  
Off : Normal  
Mode1 : Brightness of back-light is reduced.  
Mode2 : Brightness of back-light is reduced more than 1.  
Mode3 : Brightness of back-light is reduced more than 2.
- \* Eco is disabled when i-Style Color, Adv. Contrast or Color Temp. sRGB is activated.

- **Blue Light Reducer \*** : Pressing and holding of the + Button for 3 seconds when the Menu is not displayed.  
Off : Normal  
Mode1 : Blue light is reduced.  
Mode2 : Blue light is reduced more than Mode1.  
Mode3 : Blue light is reduced more than Mode2.

\* Blue Light Reducer is disabled when i-Style Color or Color Temp. sRGB is activated.

- **Lock Mode :**

**<OSD>**

Hold the MENU button and turn on the monitor when the monitor is power-off, it will lock/unlock the OSD Key Lock function.

**<POWER/OSD>**

Pressing and holding the MENU button for 10 seconds when Menu is not displayed, will lock/unlock the Power/OSD Key Lock function.

## SCREEN ADJUSTMENTS

Adjust the image by following the procedure below to get the desired picture when selecting Analog input.

- The screen adjustments described in this manual are designed to set image position and minimize flicker or blur for the particular computer in use.
- The monitor is designed to provide the best performance at resolution of 1920 × 1080, but can not provide the best at resolutions of less than 1920 × 1080 because the picture is automatically stretched to fit the full screen. It is recommended to operate at resolution of 1920 × 1080 in normal use.
- Displayed text or lines will be blurred or irregular in thickness when the picture is stretched due to the screen enlargement process.
- It is preferable to adjust the image position and frequency with the monitor controls, rather than the computer software or utilities.
- Perform adjustments after a warm-up period of at least thirty minutes.
- Additional adjustments may be required after the Auto Image Adjust depending on the resolution or signal timing.
- The Auto Image Adjust may not work correctly when displaying the picture other than the screen adjustment pattern. In this case, manual adjustments are required.

There are two ways to adjust the screen. One way is automatic adjustment for Position, Clock and Phase. The other way is performing each adjustment manually.

Perform the Auto Image Adjust first when the monitor is connected to a new computer, or resolution is changed. If the screen has a flicker or blur, or the picture does not fit in the display area after performing the Auto Image Adjust, manual adjustments are required. Both adjustments should be made by using the screen adjustment pattern (Test.bmp) obtained via the IIYAMA web site (<http://www.iiyama.com>).

Adjust the image by following the procedure below to get the desired picture.

This manual explains adjustment under Windows® OS.

- ① **Display the picture at the optimum resolution.**
- ② **Enter the Test.bmp (screen adjustment pattern) to wallpaper.**

### NOTE

- Consult the appropriate documentation for doing this.
- Set the display position to center in the wallpaper setting dialogue box.

[Adjustment pattern]

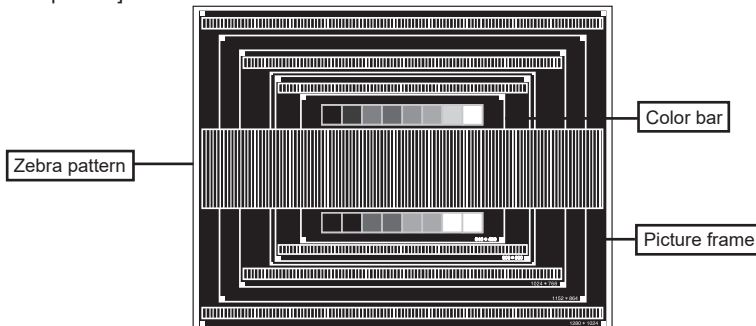

- ③ Pressing and holding of the AUTO Button for about 2-3 seconds. (Auto Configure)
- ④ Adjust the image manually by following procedure below when the screen has a flicker or blur, or the picture does not fit in the display area after performing the Auto Image Adjust.
- ⑤ Adjust the V.Position so that the top and bottom of the picture frame will fit to the display area.

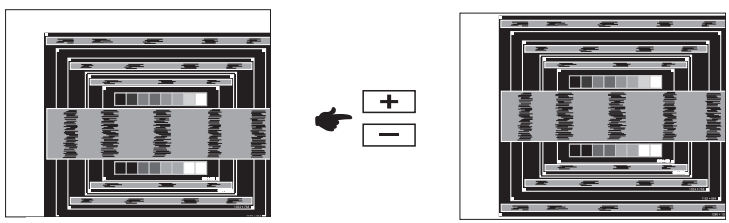

- ⑥ 1) Adjust the H.Position so that the left side of the picture frame will move to the left edge of the display area.

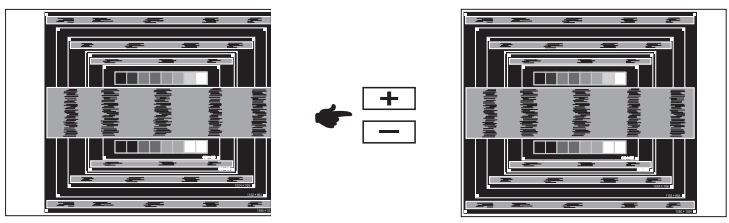

- 2) Stretch the right side of the picture frame to the right edge of the display area by adjusting the Clock.

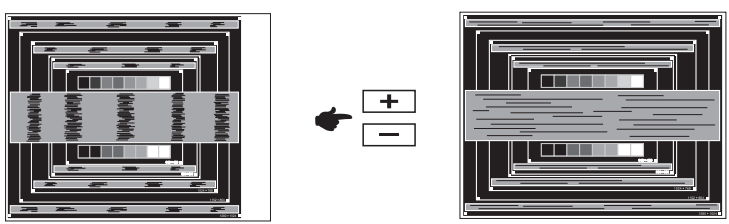

**NOTE**

- When the left side of the picture frame moves apart from the left edge of the display area during the Clock adjustment, adjust steps 1) and 2).
- Another way to make the Clock adjustment is to correct the vertical wavy lines in the zebra pattern.
- The picture may flicker during the Clock, H.Position and V.Position adjustment.
- In case the picture frame is bigger or smaller than the data display area after the Clock adjustment, repeat steps from ③.

- ⑦ **Adjust the Phase to correct horizontal wavy noise, flicker or blur in the zebra pattern.**

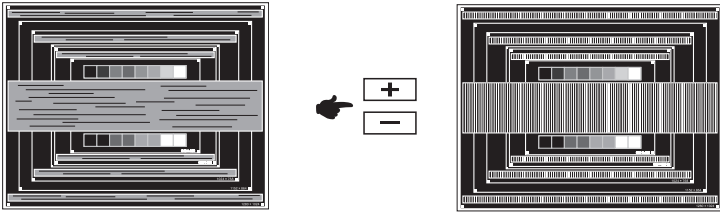

**NOTE**

- In case the strong flicker or blurs remain on a part of the screen, repeat steps ⑥ and ⑦ because the Clock may not be adjusted correctly.
- Adjust the H.Position after the Phase adjustment if the horizontal position moves during the adjustment.

- ⑧ **Adjust the Brightness and Color to get the desired picture after you complete the Clock and Phase adjustments.**

**Put back your favorite wallpaper.**



## STANDBY FEATURE

The standby feature of this product complies with power saving requirement of VESA DPMS. When activated, it automatically reduces unnecessary power consumption of the monitor when your computer is not in use.

To use the feature, the monitor needs to be connected to a VESA DPMS compliant computer. There is a standby step the monitor takes as described below. The standby function, including any timer settings is configured by the operating system. Check your operating system manual for information on how this can be configured.

### ■ Standby Mode

When the video signal from the computer is off, the monitor enters into Standby Mode which reduces the power consumption to less than 0.5W\*. The screen becomes dark, and the power indicator turns to orange. From Standby Mode, the image reappears in several seconds when either the keyboard or the mouse are touched again.

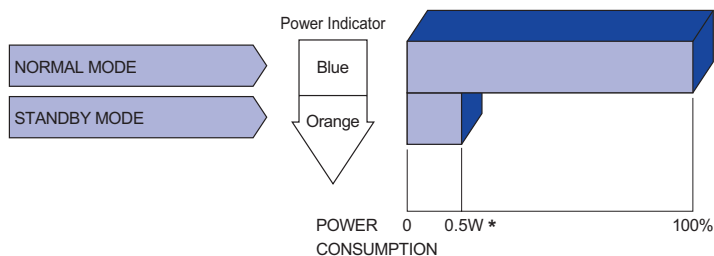

\* USB peripherals and audio equipment are not connected.

### NOTE

Even when using the standby mode, the monitor consumes electricity. Turn off the Power Switch whenever the monitor is not in use, during the night and weekends, to avoid unnecessary power consumption.

# TROUBLE SHOOTING

If the monitor fails to operate correctly, please follow the steps below for a possible solution.

1. Perform the adjustments described in OPERATING THE MONITOR, depending on the problem you have. If the monitor does not get a picture, skip to 2.
2. Consult the following items if you cannot find an appropriate adjustment item in OPERATING THE MONITOR or if the problem persists.
3. If you are experiencing a problem which is not described below or you cannot correct the problem, discontinue using the monitor and contact your dealer or iiyama service center for further assistance.

## Problem

## Check

- ① The picture does not appear.

(Power indicator does not light up.)

- The Power Cable is firmly seated in the socket.
- The Power Switch is turned ON.
- The AC socket is live. Please check with another piece of equipment.

(Power indicator is blue.)

- If the blank screen saver is in active mode, touch the keyboard or the mouse.
- Increase the Contrast and/or Brightness.
- The computer is ON.
- The Signal Cable is properly connected.
- The signal timing of the computer is within the specification of the monitor.

(Power indicator is orange.)

- If the monitor is in standby mode, touch the keyboard or the mouse.
- The computer is ON.
- The Signal Cable is properly connected.
- The signal timing of the computer is within the specification of the monitor.

- ② The screen is not synchronized.

- The Signal Cable is properly connected.
- The signal timing of the computer is within the specification of the monitor.

- ③ The screen position is not in the center.

- The signal timing of the computer is within the specification of the monitor.

- ④ The screen is too bright or too dark.

- The video output level of the computer is within the specification of the monitor.

## Problem

## Check

- |                                       |  |
|---------------------------------------|--|
| ⑤ The screen is shaking.              | <input type="checkbox"/> The power voltage is within the specification of the monitor.<br><input type="checkbox"/> The signal timing of the computer is within the specification of the monitor.   |
| ⑥ No sound.                           | <input type="checkbox"/> The audio equipment (computer etc.) is ON.<br><input type="checkbox"/> The Audio Cable is properly connected.<br><input type="checkbox"/> The Volume is turned up.<br><input type="checkbox"/> The Mute is OFF.<br><input type="checkbox"/> The audio output level of the audio equipment is within the specification of the monitor. |
| ⑦ The sound is too loud or too quiet. | <input type="checkbox"/> The audio output level of the audio equipment is within the specification of the monitor.   |
| ⑧ A strange noise is heard.           | <input type="checkbox"/> The Audio Cable is properly connected.  |

## RECYCLING INFORMATION

For better environment protection please don't dispose your monitor.  
Please visit our web site: [www.iiyama.com](http://www.iiyama.com) for monitor recycling.

# APPENDIX

Design and specifications are subject to change without prior notice.

## SPECIFICATIONS

ENGLISH

Size Category	28"	
LCD Panel	Panel technology	TN
	Size	Diagonal: 28" (71cm)
	Pixel pitch	0.16mm H × 0.16mm V
	Brightness	300cd/m <sup>2</sup> (Typical)
	Contrast ratio	1000 : 1 (Typical), Adv. Contrast Function Available
	Viewable angle	Right / Left : 85 degrees each, Up / Down : 80 degrees each (Typical)
	Response time	5ms (Typical), 1ms (Gray to Gray)
Display Colors	Approx. 1.07Billion	
Sync Frequency	VGA: Horizontal: 30.0-80.0kHz, Vertical: 55-75Hz DVI: Horizontal: 30.0-135.0kHz, Vertical: 30-75Hz HDMI: Horizontal: 30.0-135.0kHz, Vertical: 30-75Hz DisplayPort(without FreeSync) : Horizontal: 30.0-135.0kHz, Vertical: 30-75Hz DisplayPort(with FreeSync): Horizontal: 30.0-135.0kHz, Vertical: 30-75Hz	
Native Resolution	3840 × 2160, 8.2 MegaPixels	
Support max. resolution	VGA: 1920 × 1080 60Hz DVI: 2560 × 1440 60Hz, 3840 × 2160 30Hz HDMI: 3840 × 2160 60Hz DisplayPort(without FreeSync): 3840 × 2160 60Hz DisplayPort(with FreeSync): 3840 × 2160 60Hz	
Input Connector	VGA, DVI-D, HDMI, DisplayPort	
Plug & Play	VESA DDC2B™	
Input Sync Signal	Separate sync: TTL, Positive or Negative	
Input Video Signal	Analog: 0.7Vp-p (Standard), 75Ω, Positive Digital: DVI (Digital Visual Interface Standard Rev.1.0) compliance Digital: HDMI, DisplayPort	
USB Standard	USB3.0 (DC5V, 900mA) × 1, USB3.0 Battery Charger (DC5V, 900mA) × 1, USB2.0 (DC5V, 500mA) × 2	
Number of USB Ports	1 Upstream : Series B	
Connector shape	4 Downstream : Series A	
Input Audio Connector	ø 3.5mm mini jack (Stereo)	
Input Audio Signal	1.0Vrms maximum	
Output Audio Connector	ø 3.5mm mini jack (Stereo)	
Speakers	2.5W × 2 (Stereo speakers)	
Maximum Screen Size	620.93mm W × 341.28mm H / 24.4" W × 13.4" H	
Power Source	100-240VAC, 50/60Hz, 1.5A	
Power Consumption*	44W typical, Standby mode: 0.5W maximum	
Dimensions / Net Weight	659.5 × 410.5 - 540.5 × 230.0mm / 26.0 × 16.2 - 21.3 × 9.1" (W×H×D) 7.5kg / 16.5lbs	
Tilt Angle	Upward: 17 degrees, Left/Right: 45 degrees each	

**NOTE** \* USB peripherals and audio equipment are not connected.

Environmental Considerations	Operating:	Temperature	5 to 35°C / 41 to 95°F
		Humidity	10 to 80% (No condensation)
Approvals	Storage:	Temperature	-20 to 60°C / -4 to 140°F
		Humidity	5 to 85% (No condensation)
		Approvals	CE, UKCA, TÜV-Bauart, EAC, VCCI, PSE

**DIMENSIONS**

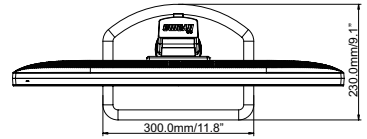
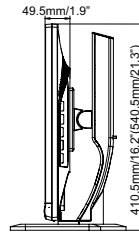
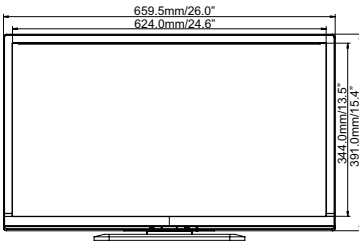

( ) : Maximum adjustment range

## COMPLIANT TIMING

Video Mode	Horizontal Frequency	Vertical Frequency	Dot Clock
640 × 480	31.469kHz	59.940Hz	25.175MHz
	37.500kHz	75.000Hz	31.500MHz
	37.861kHz	72.809Hz	31.500MHz
800 × 600	35.156kHz	56.250Hz	36.000MHz
	37.879kHz	60.317Hz	40.000MHz
	46.875kHz	75.000Hz	49.500MHz
1024 × 768	48.363kHz	60.004Hz	65.000MHz
	56.476kHz	70.069Hz	75.000MHz
	60.023kHz	75.029Hz	78.750MHz
1280 × 1024	63.981kHz	60.020Hz	108.000MHz
	79.976kHz	75.025Hz	135.000MHz
1440 × 900	55.935kHz	59.887Hz	106.500MHz
	70.635kHz	74.984Hz	136.750MHz
1680 × 1050	65.290kHz	60.000Hz	146.250MHz
1920 × 1080	66.590kHz	59.930Hz	138.500MHz
2560 × 1440	88.787kHz	59.951Hz	241.500MHz
3840 × 2160	67.430kHz	29.970Hz	296.700MHz
	133.313kHz	59.997Hz	533.250MHz
1920 × 2160	133.293kHz	59.988Hz	277.250MHz

\*4

\*1

\*2

\*1,3

**NOTE** \*1 DVI, HDMI and DisplayPort input only. For DVI input, dual link DVI cable must be used.

\*2 HDMI and DisplayPort input only.

\*3 Recommended to use on PbP mode.

\*4 DVI and HDMI input only.

For HDMI input, select "HDMI 1.4" of Input Select.

For DVI input, dual link DVI cable must be used.